

DALI

narożnik typ A (P/L)

302/366

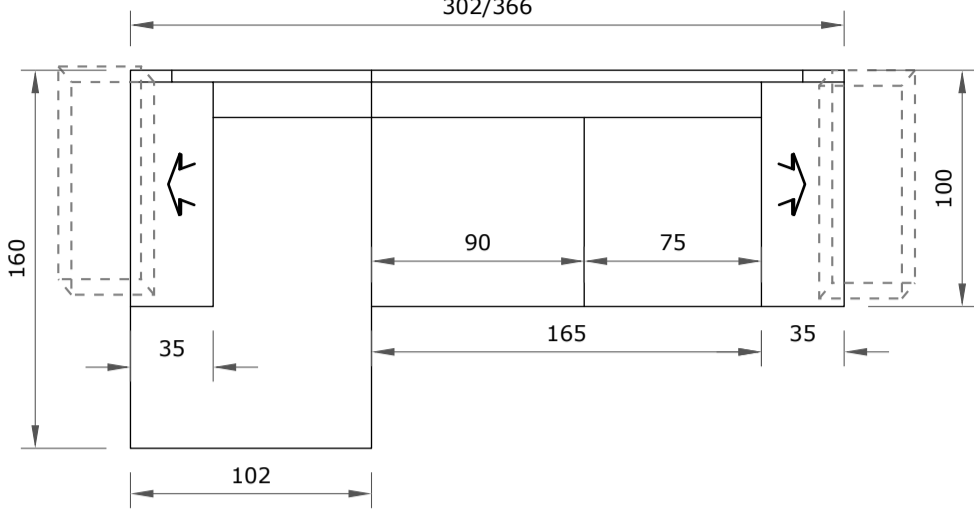

narożnik typ B (P/L)

272/336

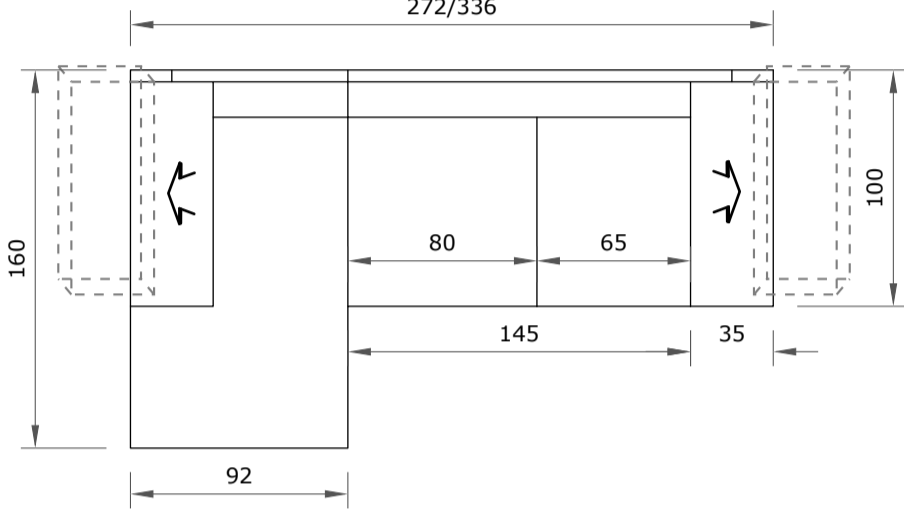

sofa 3os

250/314

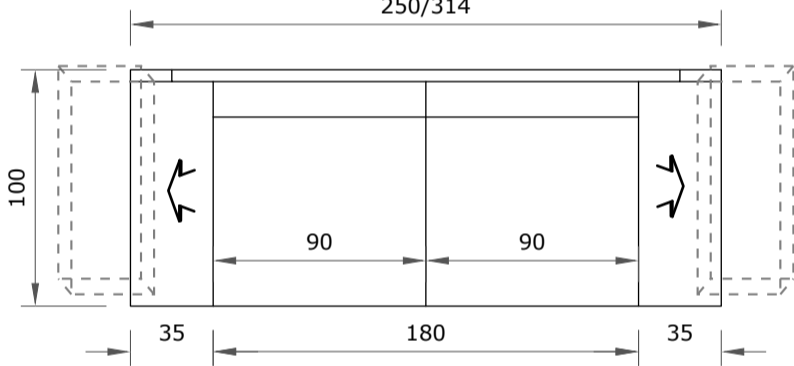

sofa 2os

190/254

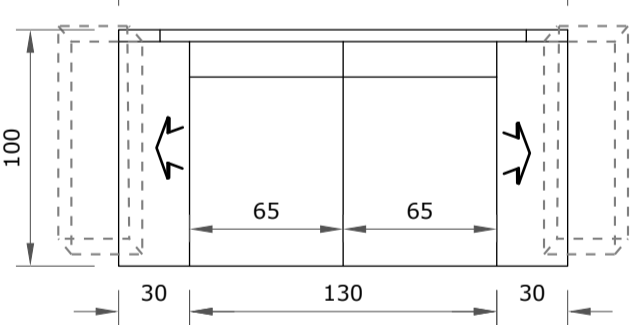

fotel

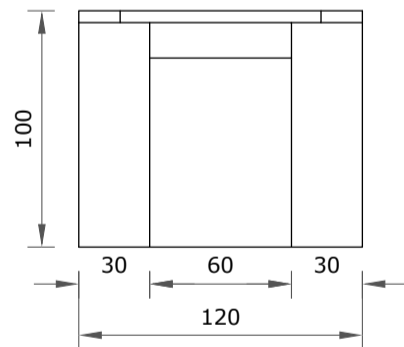

**moduł 1os A
M1A**

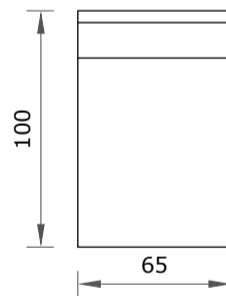

**moduł 1os B
M1B**

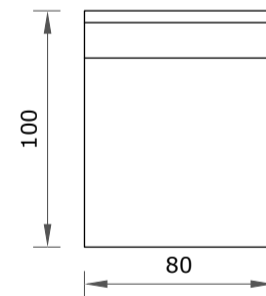

**moduł 1os C
M1C**

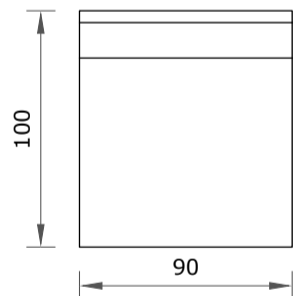

**moduł 2os
M2P**

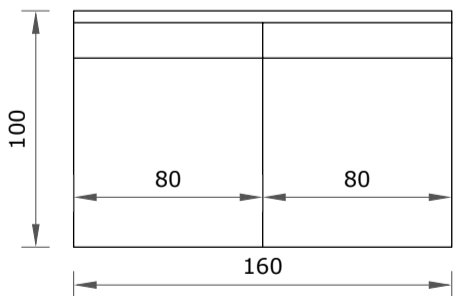

**element narożny
N**

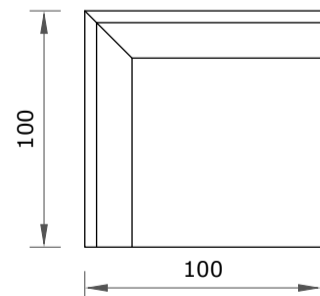

**moduł 2os + podłokietnik
M2P (P/L)**

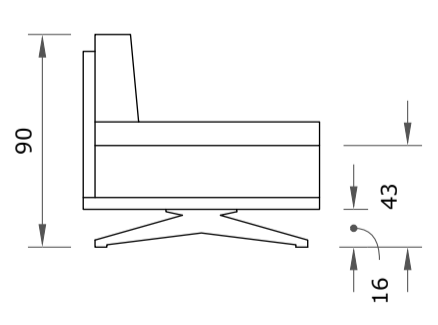
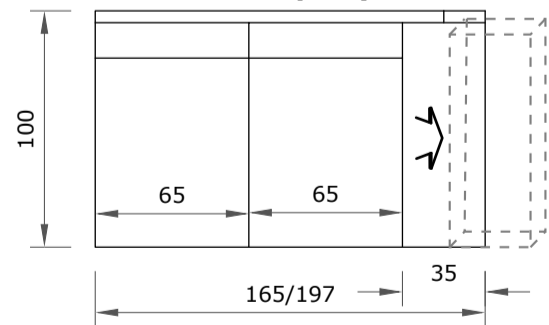

**moduł 1os + podłokietnik
M1P (P/L)**

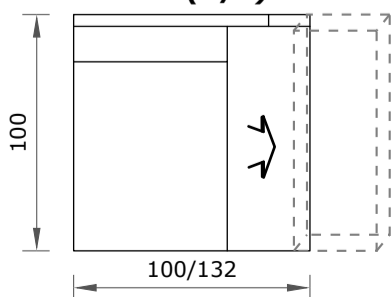

**moduł 1os z pufą
M1PUF (P/L)**

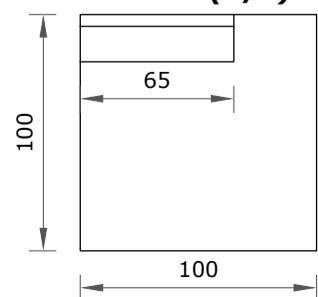

pufa A

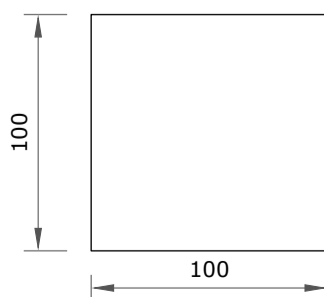

pufa B

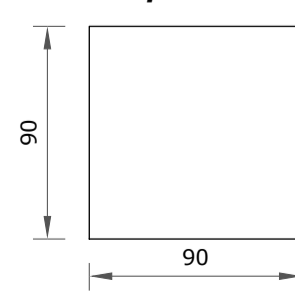

pufa C

